

System Diamond 140/160/180/200 x 200



D Montageanleitung

GB Assembly instructions

NL Handleiding voor de montage

PL Instrukcja montażu

TR Montaj talimatı

RU Инструкция по монтажу

RO Instrucțiunile de instalare

I Istruzioni per l'installazione

F Instructions d'installation

SK Návod na inštaláciu

CZ Návod k instalaci

H Telepítési utasítások

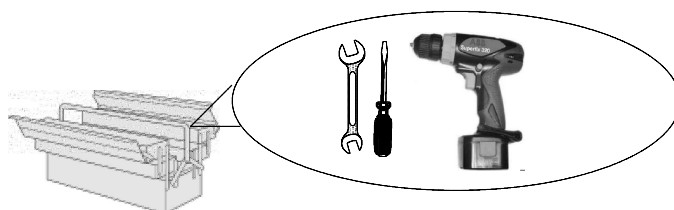
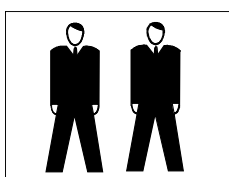

280120160

Service • Dienstverlening • Serwis • Servis • Сервисная служба

Name • Naam • Nazwa • Isim • Название

System Diamond

Nr. • No. • Номер

Typ • Type • Тип • Тип

140/160/180/200 x200

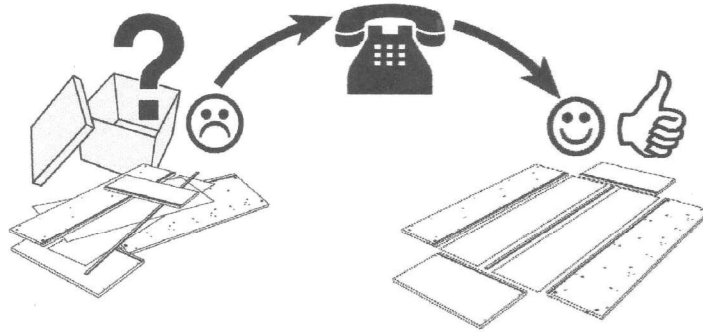
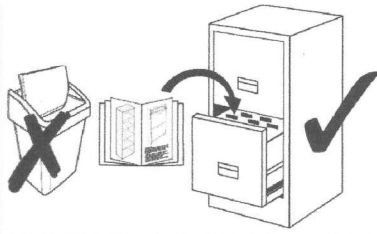

A	8X	B	4X	C	KT 2	4X	D	1X	E	8X
Senkkopfschraube M6x20		Metall- verbinder		Schraube M6			Bettklemme		Fuß 10cm	
F	4X	G	2X	H		1X				
Schraube M8x20				13						

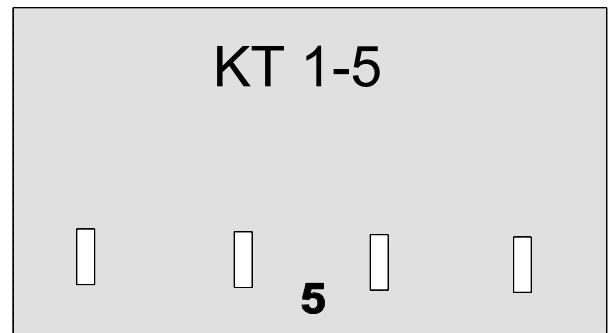

**KT 2
+6L, +6R**

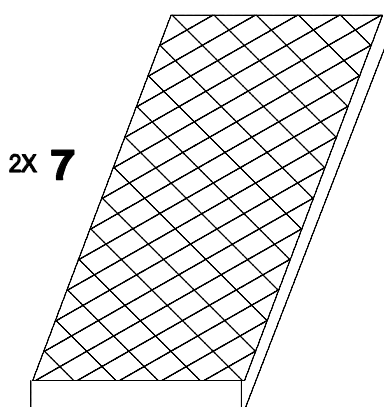
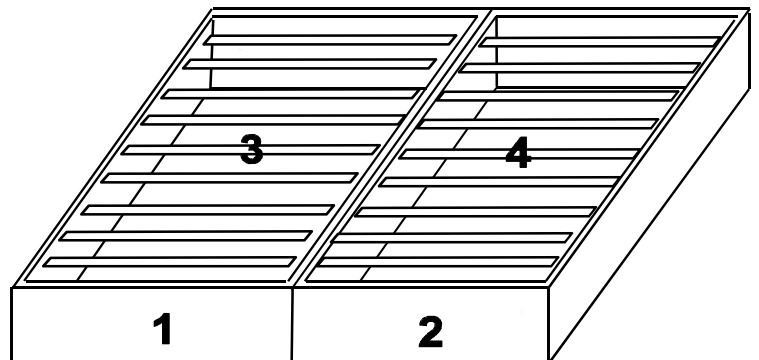
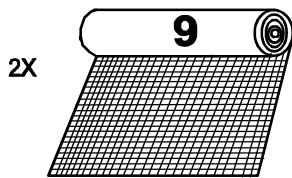
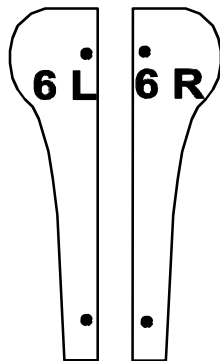

oder
or
ou
of
o
veja
lub
nebo
alebo
vagy
или
sau

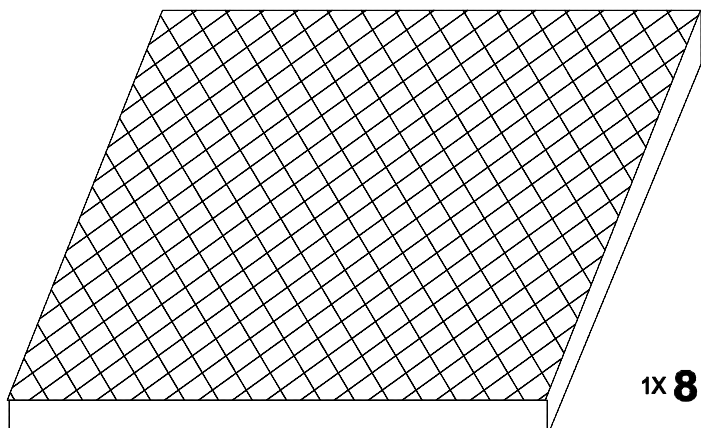

0
10
20
30
40
50
60
70
80
90
100
110
120
130
140
150
160
170
180
190
200

1.

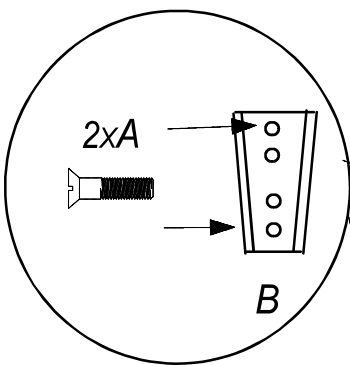
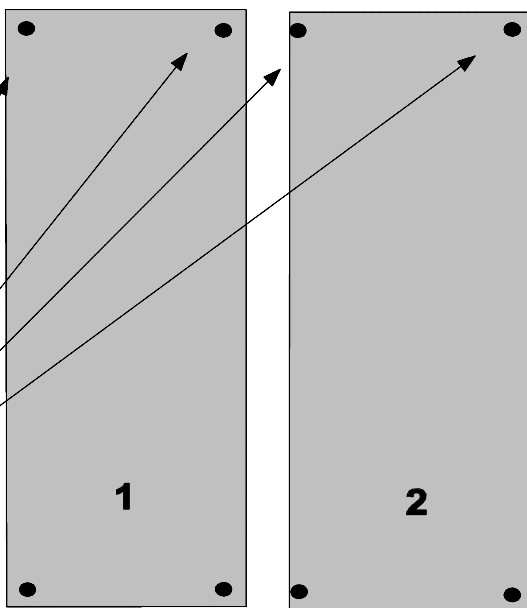
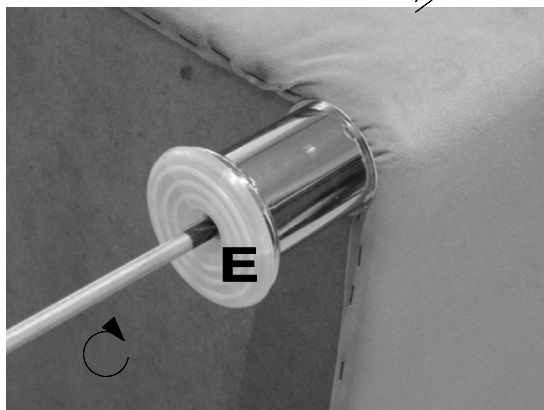

2.

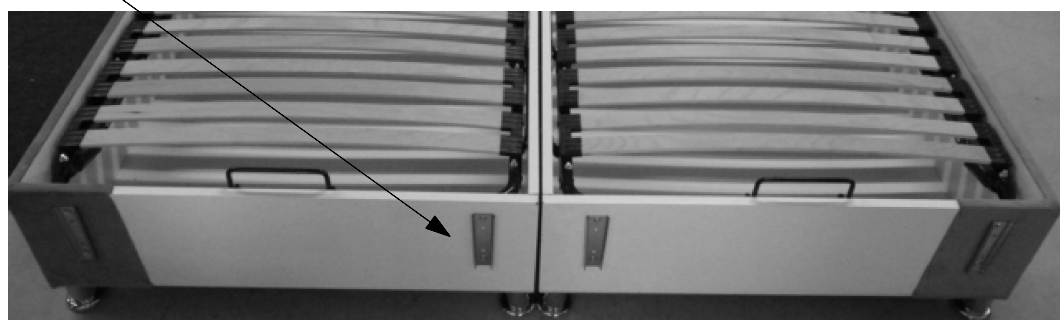
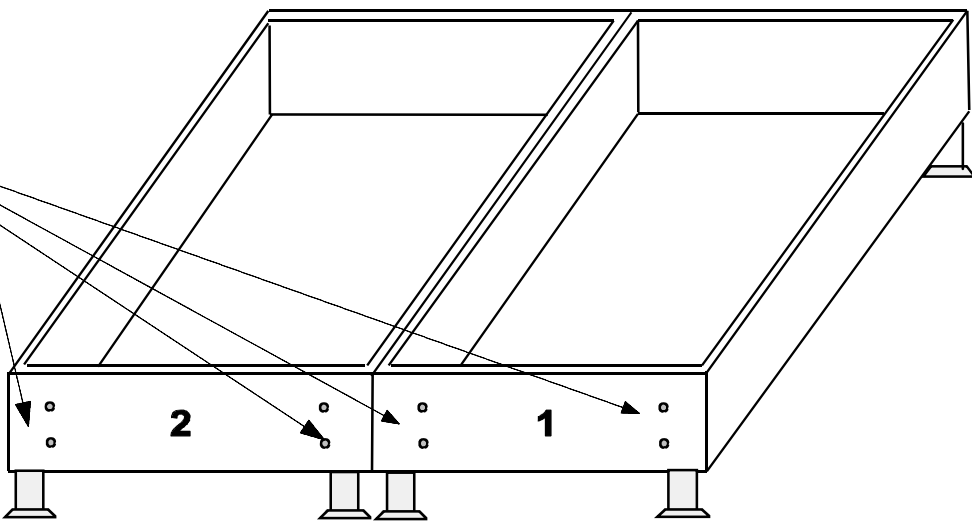



3.

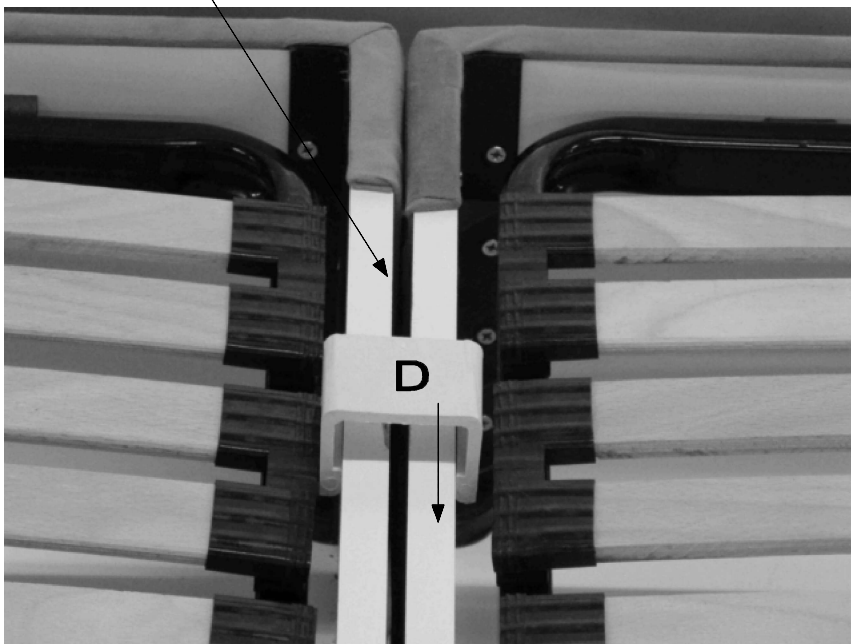
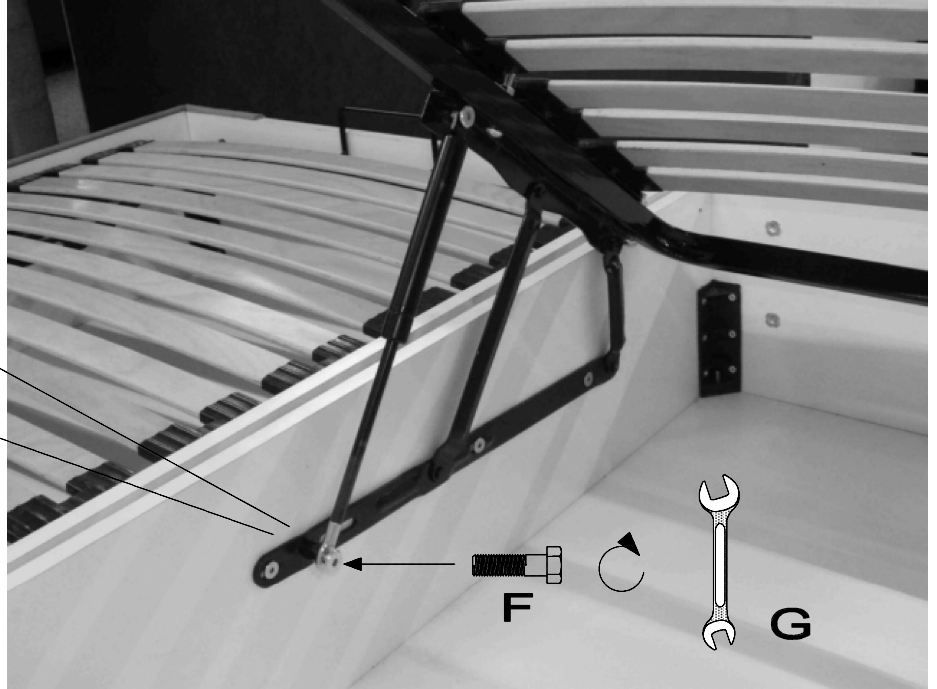

4.

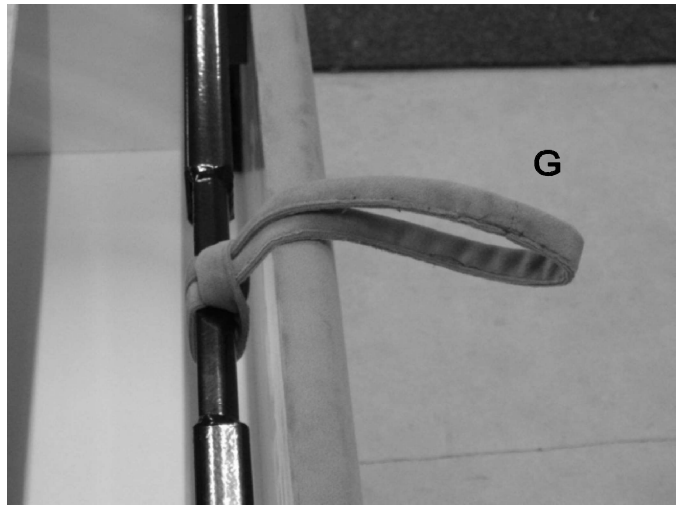
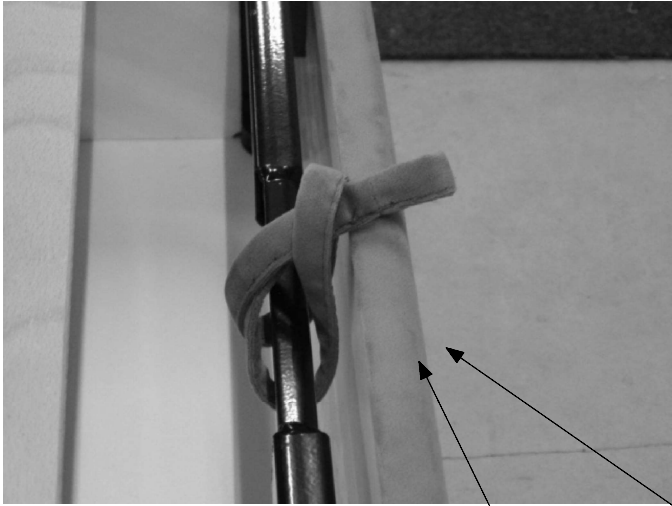

5.



6.

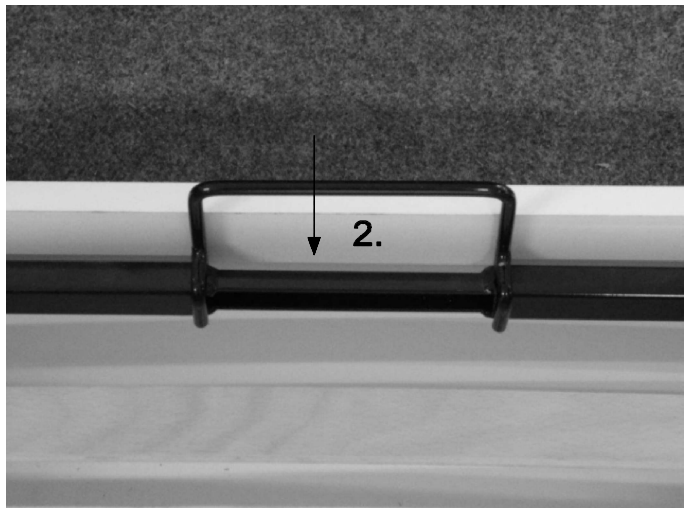
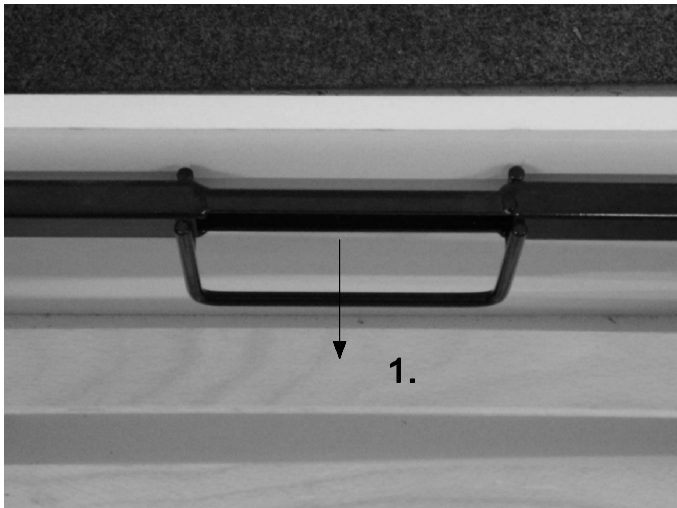

7.

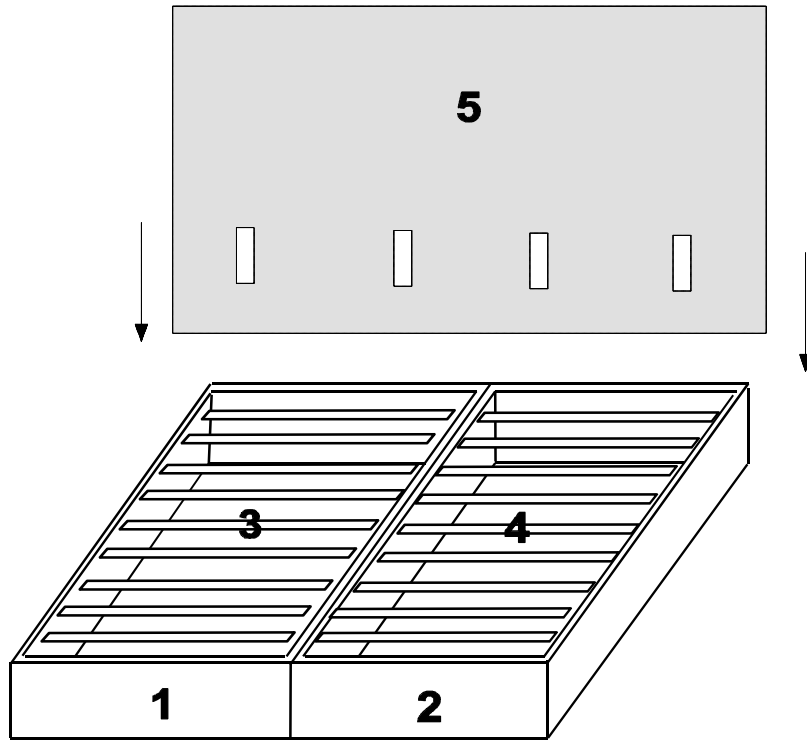

7.1

KT 2

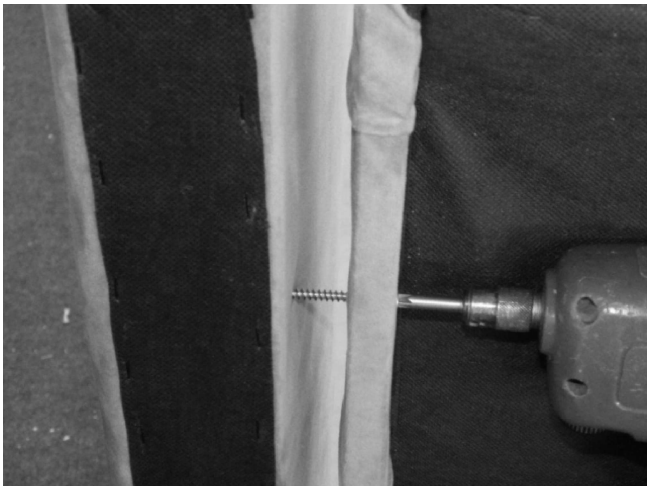
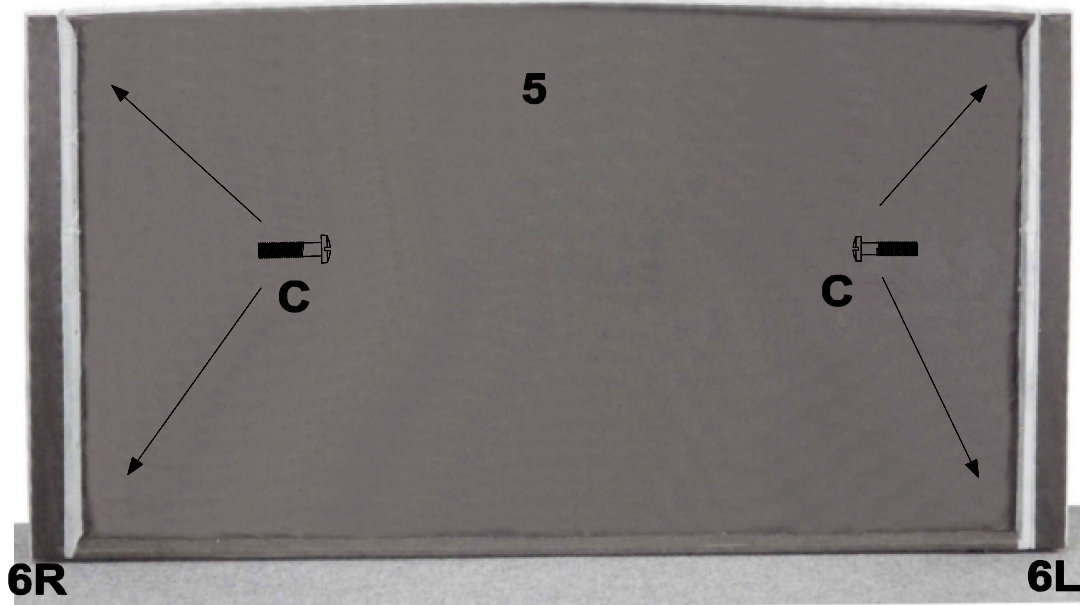

8.

